

Yoke Swivel Hoist Ring - type 203 metric thread with alloy steel washer

- Rotates through 360° and pivots 180°, rated at 100% at 90° angle.
- Manufactured from forged alloy steel, quenched and tempered.
- Manufactured and tested in accordance with EN1677-1.
- Load rated parts are 100% magnaflux crack detected.
- Individual forged parts and cap screw are traceable to Test Certification.
- Bolts are Metric thread (ASME / ANSI B18.3.1M).
- Proof tested to 2.5 times the WLL. on the 4 : 1 factor.
- Fatigue rated to 1.5 times the WLL.
- Design Factor 4 : 1
- All YOKE Lifting points meet or exceed all the requirements of ASME B30.26.
- Quick and simple assembly, just a tapped hole is required.

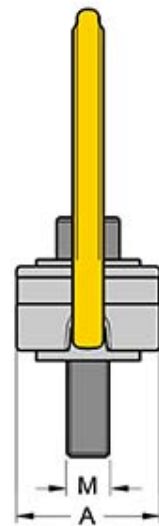
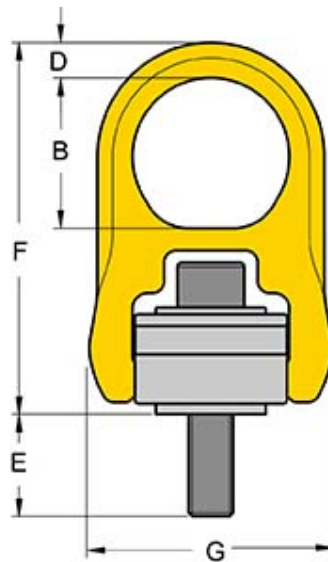
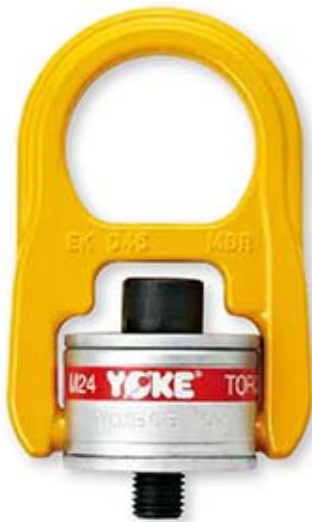

DIMENSIONAL SPECIFICATIONS

Part Code	WLL tonnes 5 : 1	WLL tonnes 4 : 1	Thread M	A mm	B mm	D mm	E mm	F mm	G mm	Torque Nm	Mass Kg	CAD Files
8-203-004	0.40	0.50	M8 x 1.25	40	41	9	17	102	65	10	0.4	
8-203-005	0.45	0.55	M10 x 1.5	40	41	9	11	102	65	16	0.5	
8-203-010	1.05	1.30	M12 x 1.75	65	64	15	15	158	105	38	1.7	
8-203-019	1.90	2.40	M16 x 2	65	64	15	20	158	105	81	1.8	
8-203-021	2.15	2.70	M20 x 2.5	65	64	15	25	158	105	136	1.8	
8-203-042	4.20	5.25	M24 x 3	85	79	19	26	204	134	312	4.2	
8-203-070	7.00	8.75	M30 x 3.5	100	100	25	81	241	160	637	6.6	
8-203-110	11.00	13.75	M36 x 4	120	111	30	76	286	194	1005	15.0	
8-203-125	12.50	15.60	M42 x 4.5	120	111	30	65	286	220	1005	16.0	
8-203-135	13.50	16.90	M48 x 5	120	111	30	70	286	220	1350	16.0	









Bolt in GEOMET finish on request.

USES

Swivel Hoist Ring uses can be as follows:

- Heavy duty flexible attachment point
- Suited for lifting objects with no obvious attachment points
- Mold and die handling
- Pump and valve handling

SWIVEL HOIST RING - TYPE 203 WORKING LOAD APPLICATION FACTORS

											
Number of legs		1	2	1	2	2		2	3-4		3-4
Load Direction		0°	0°	90°	90°	0-45°	45-60°	unsymm.	0-45°	45-60°	unsymm.
Part Code	Thread	WLL tonnes									
8-203-004	M8	0.5	1	0.5	1	0.7	0.5	0.5	1.05	0.75	0.5
8-203-005	M10	0.55	1.1	0.55	1.1	0.77	0.55	0.55	1.16	0.83	0.55
8-203-010	M12	1.3	2.6	1.3	2.6	1.82	1.3	1.3	2.73	1.95	1.3
8-203-019	M16	2.4	4.8	2.4	4.8	3.36	2.4	2.4	5.04	3.6	2.4
8-203-021	M20	2.7	5.4	2.7	5.4	3.78	2.7	2.7	5.67	4.05	2.7
8-203-042	M24	5.25	10.5	5.25	10.5	7.35	5.25	5.25	11.03	7.88	5.25
8-203-070	M30	8.75	17.5	8.75	17.5	12.25	8.75	8.75	18.38	13.13	8.75
8-203-110	M36	13.75	27.5	13.75	27.5	19.25	13.75	13.75	28.88	20.63	13.75
8-203-125	M42	15.6	31.2	15.6	31.2	21.84	15.6	15.6	32.76	23.4	15.6
8-203-135	M48	16.9	33.8	16.9	33.5	23.66	16.9	16.9	35.49	25.35	16.9

Click here to view video of Yoke Load Attachment Products

<http://www.yoke.net/video/en.asp>