

Features and benefits:

- Proprietary 2.4 GHz wireless
 - Accuracy of $\pm 0.1\%$ FS
 - Environmentally sealed to IP67 or NEMA6
 - Stocked capacities up to 1000t
 - Industry leading wireless range up to 1000m or 3280ft
 - Internal antennae
 - ATEX & IECEx version for hazardous area zones 0, 1 & 2 available
 - Battery life of 1200hrs
 - Compact size
 - Remote On-Off from handheld display or software
 - Design validated by F.E.A.
- Bluetooth option is available and is supplied with a free HHP App for iOS and Android

The Straightpoint LoadSafe Compression Loadcell.

No longer hindered by troublesome and hard to maintain cables, large-scale projects can now be completed in a fraction of the time previously required. Multiple compression load cells can all connect wirelessly to INSIGHT via a USB dongle, their iOS or Android app (If Bluetooth), or their SW-HHP wireless handheld display.

Maintenance and repair costs are all but eliminated due to the absence of cables and connectors. The flexibility of the product opens the door to a large number of applications in the heavy lift, energy, defence, rigging, shipping, and general transportation sectors.

Two versions of the WNI are available:

- Long range 2.4GHz version providing industry leading wireless range to Crosby|Straightpoint's SW-HHP handheld or INSIGHT.
- Bluetooth output and can be connected to any smart phone running our free HHP app on iOS or Android, at ranges up to 100m or 328ft.

Connected to Crosby|Straightpoint's INSIGHT, the WNI load cell can be used to weigh and verify centre of gravity of large and heavy objects, which may not be evenly proportioned. The

system will report weight on each individual load cell, total weight and C-of-G in an html report based on ISO19901.

Crosby|Straightpoint's LoadSafe is machined from high grade 17-4PH stainless steel, providing excellent strength and corrosion resistance, which makes them suitable for the most arduous industrial conditions.

Also available with hazardous area approval. Zones 0, 1 & 2



ATEX / IECEx
Ex ia II C T4 Ga

Certification numbers:
WNI ATEX
 IECEx SIR 16.0041X / Sira 16ATEX2108X
SW-HHP ATEX
 IECEx SIR 15.0072X / Sira 15ATEX2196X

Add 'ATEX' to the part number when ordering ATEX/IECEx products. For example: WNI5TC-ATEX

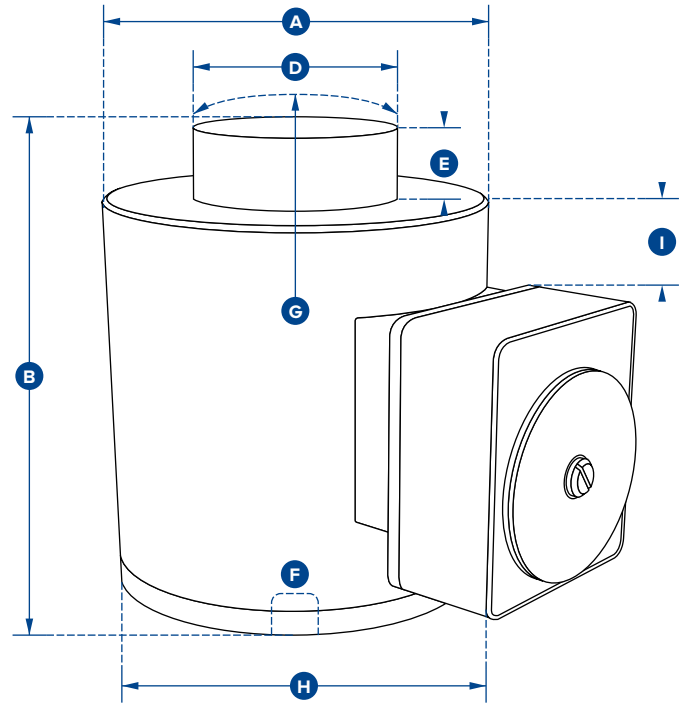

Part Numbers	WNI5TC	WNI10TC	WNI25TC	WNI50TC	WNI100TC	WNI150TC	WNI300TC	WNI500TC	WNI1000TC
SP	2789157	2789191	2789193	2789196	2789190	2789192	2789194	2789195	2789138
Capacity	5te 11000lb	10te 22000lb	25te 55000lb	50te 110000lb	100te 220000lb	150te 330000	300te 660000lb	500te 1100000lb	1000te 2200000lb
Resolution	0.001te 2lb	0.002te 5lb	0.005te 10lb	0.01te 20lb	0.05te 100lb	0.05te 100lb	0.1te 200lb	0.2te 500lb	0.5te 1000lb
Units	tonne lb								
Weight	6.2kg 13.64lb	6.2kg 13.64lb	6.2kg 13.64lb	6.2kg 13.64lb	15.5kg 34lb	15.5kg 34lb	65kg 143lb	65kg 143lb	172kg 379lb
Safety Factor	3:1								
Battery Type	Load cell 4 x AA Alkaline								
Battery Life	Load cell 1200 hours continuous (500hrs if Bluetooth)								
Operating Temp	-20°C to +70°C or 4°F to 158°F								
Accuracy	±0.1% of full scale								
Frequency	2.4 GHz								
System Range	1000 metres or 3280 feet (100 metres or 328 feet if Bluetooth)								
Data Rate	3Hz (configurable to 200Hz)								
Protection	IP67 or NEMA6								
Dimension ØA	100 3.94"	100 3.94"	100 3.94"	100 3.94"	152 5.98"	152 5.98"	185 7.28"	185 7.28"	362 14.25"
Dimension B	127 5.00"	127 5.00"	127 5.00"	127 5.00"	184 7.24"	184 7.24"	300 11.81"	300 11.81"	310 12.20"
Dimension ØD	59 2.32"	59 2.32"	59 2.32"	59 2.32"	80 3.15"	80 3.15"	155 6.10"	155 6.10"	270 10.63"
Dimension E	16 0.63"	16 0.63"	16 0.63"	16 0.51"	26 1.02"	26 1.02"	27.5 1.08"	27.5 1.08"	40 1.57"
Dimension F	M18 x 2.5 M18 x 2.5	M18 x 2.5 M18 x 2.5	M18 x 2.5 M18 x 2.5	M20 x 2.5 M20 x 2.5	M20 x 2.5 M20 x 2.5	M20 x 2.5 M20 x 2.5	M20 x 2.5 M20 x 2.5	M20 x 2.5 M20 x 2.5	M30 x 3.5 M30 x 3.5
Dimension G	152 5.98"	152 5.98"	152 5.98"	152 5.98"	432 17.01"	432 17.01"	432 17.01"	432 17.01"	950 37.40"
Dimension H	158 6.22"	158 6.22"	158 6.22"	158 6.22"	208 8.19"	208 8.19"	241 9.49"	241 9.49"	422 16.61"
Dimension I	22 0.87"	22 0.87"	22 0.87"	22 0.87"	33 1.30"	33 1.30"	49 1.93"	49 1.93"	102 4.02"
Load cell top to SA700 top	0.87"	0.87"	0.87"	0.87"	1.30"	1.30"	1.93"	1.93"	4.02"